

楕円側溝

■楕円側溝

参考重量 380kg

断面図

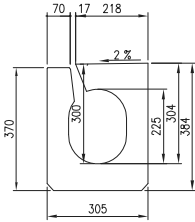

側面図

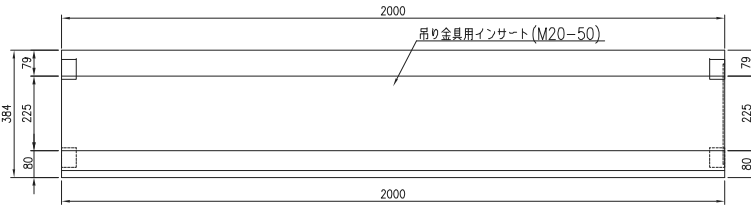

端面図

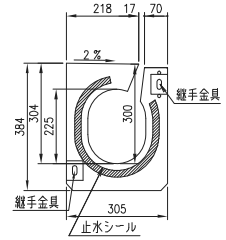

平面図

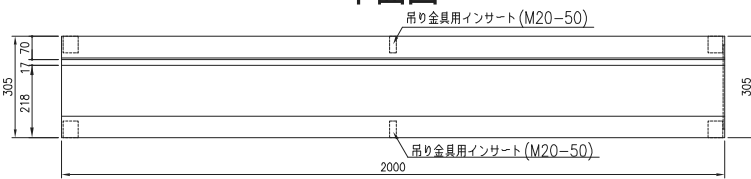

■楕円側溝用集水枳

参考重量 160kg

断面図

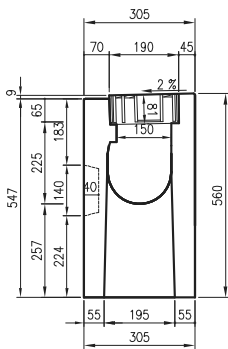

断面図

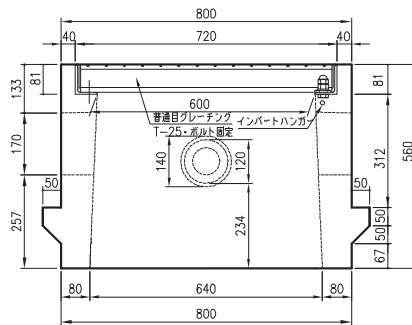

端面図

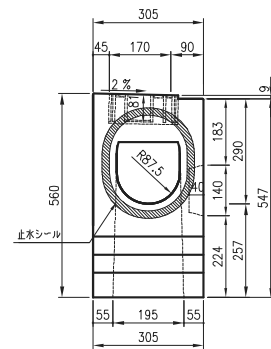

平面図

