

エコノミー側溝蓋 (NETIS登録)

グレーチング蓋

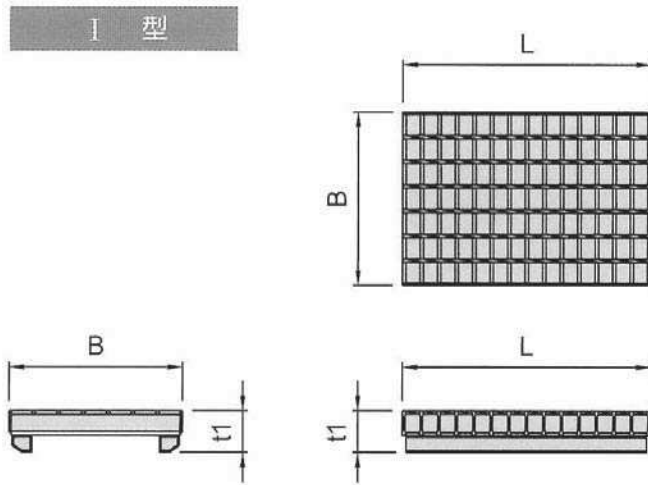

寸法表

呼び名			寸法 (mm)				参考重量 (kg)
			B	t ₁	t ₂	L	
グレーチング蓋	I型	250用	300	89	—	485	11.4
			—	—	—	995	23.6
		300用	350	84	—	501	17.0
			—	—	—	995	33.6

コンクリート蓋

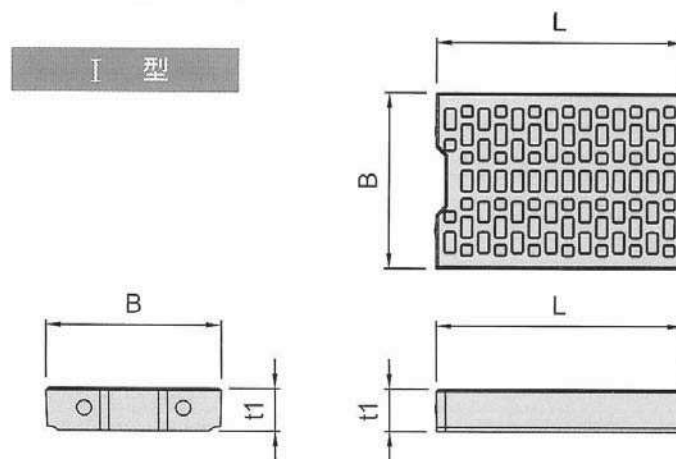

寸法表

呼び名			寸法 (mm)				参考重量 (kg)
			B	t ₁	t ₂	L	
コンクリート蓋	I型	250用	304	86	—	496	31
		300用	354	86	—	496	36

エコノミー側溝 (NETIS登録)

標準仕様

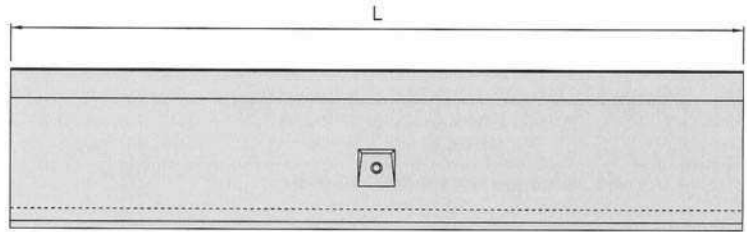
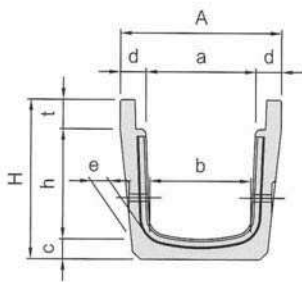

横断仕様 (Mタイプ)

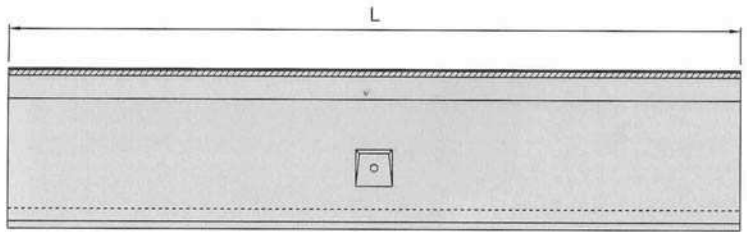
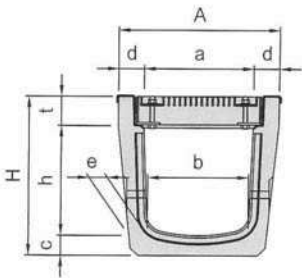

寸法表

呼び名	寸法 (mm)										参考重量 (kg)	
	A	a	H	h	b	c	d	e	t	L	L	M
250×250	390	250	385	250	230	55	70	50	80	1998	263	265
250×300	390	250	435	300	226	55	70	50	80	1998	290	292
250×400	390	250	540	400	218	60	70	55	80	1998	365	367
250×500	390	250	645	500	210	65	70	60	80	1998	445	447
300×300	440	300	435	300	276	55	70	50	80	1998	292	294
300×400	440	300	540	400	268	60	70	55	80	1998	376	382
300×500	440	300	645	500	260	65	70	60	80	1998	453	460



エコノミー側溝 (NETIS登録)

形状・寸法

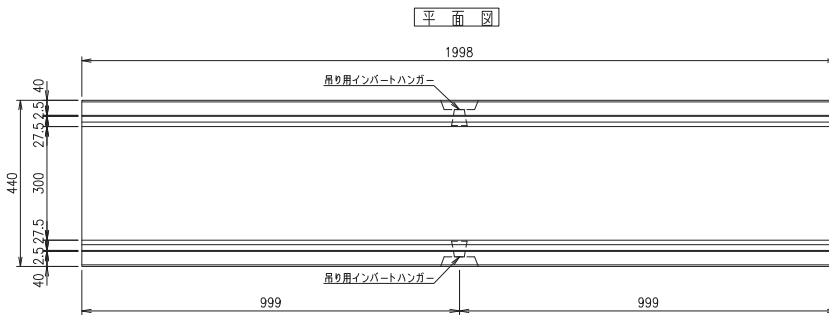
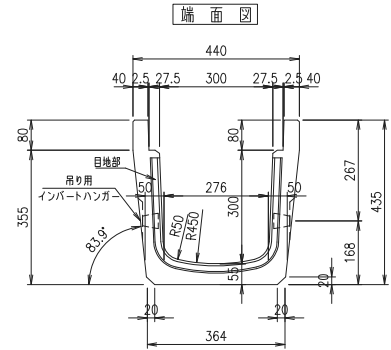
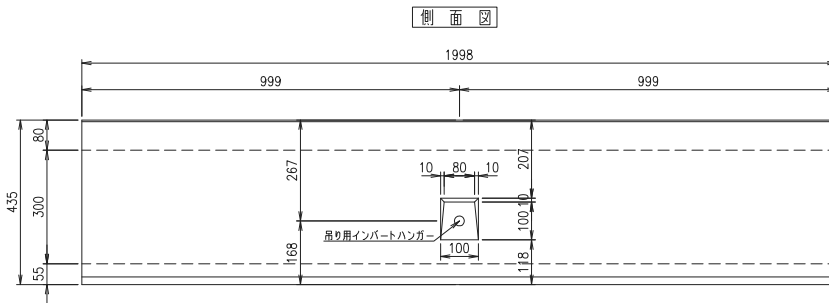

目地部詳細図 S=1/2

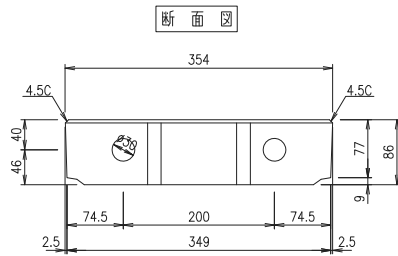
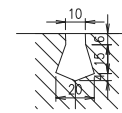

模様詳細図

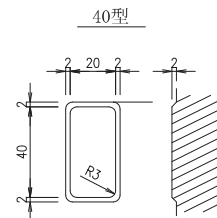

20型

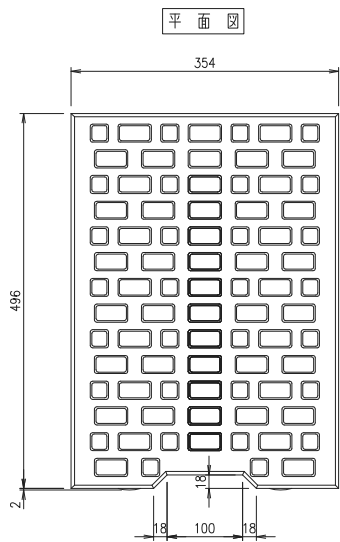
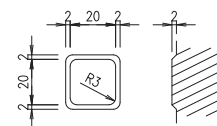

側面図

