

円形水路 NA型 (T-25)

φ300・φ300用集水桝

NA型 φ300

重量：620kg

平面図

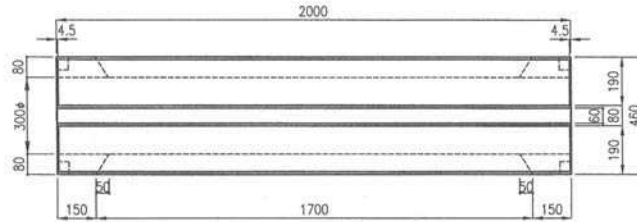

継手部詳細図

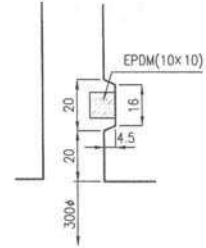

横断面図

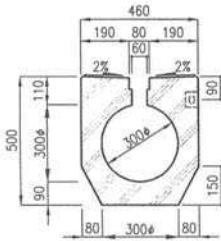

正面図

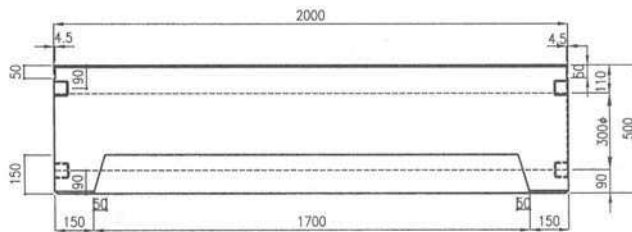

側面図

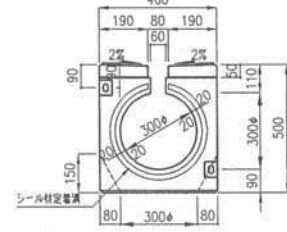

NA型 φ300用集水桝

重量：380kg

平面図

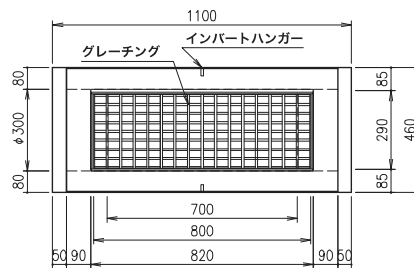

断面図

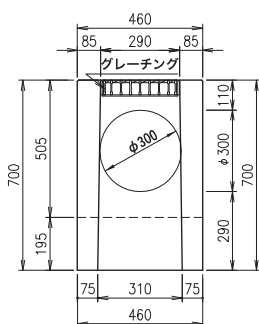

正面図

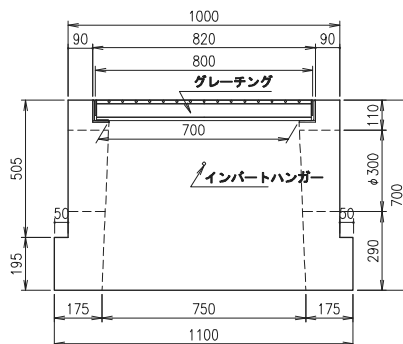

側面図

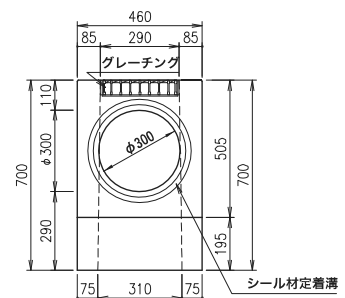

円形水路 NA型 (T-25)

φ400・φ400用集水枡

NA型 φ400

重量：1,126kg

平面図

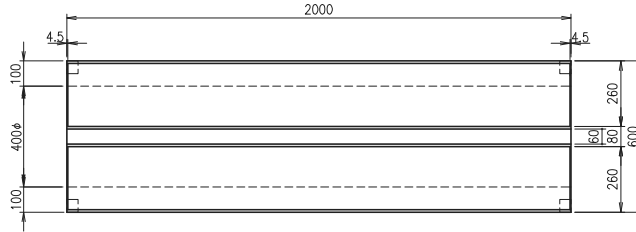

横断面図

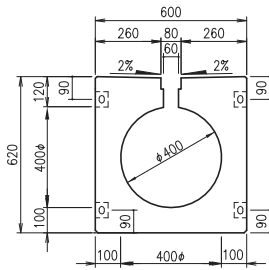

正面図

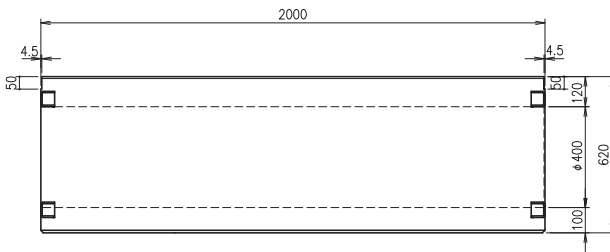

側面図

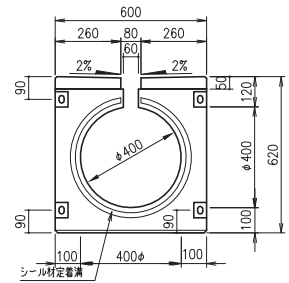

NA型 φ400用集水枡

重量：565kg

平面図

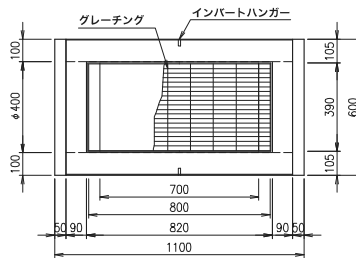

断面図

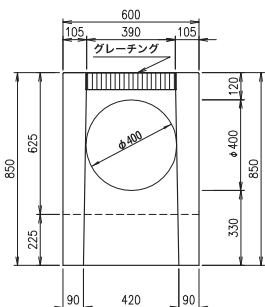

正面図

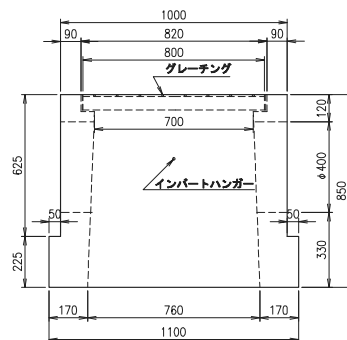

側面図

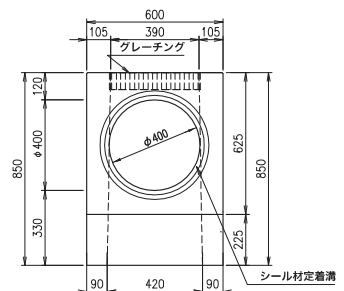

円形水路 NA型 (T-25)

φ500・φ500用集水樹

NA型 φ500

重量：1,388kg

平面図

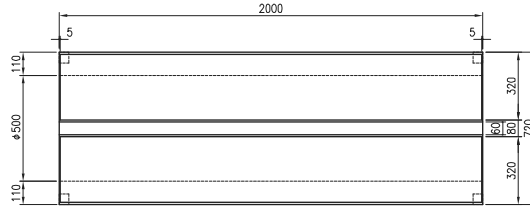

横断面図

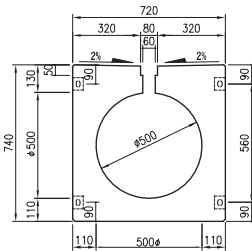

正面図

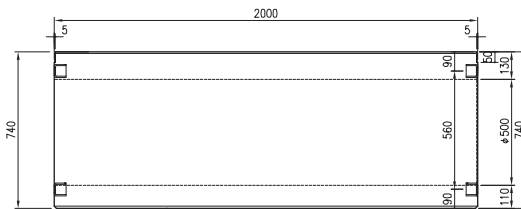

側面図

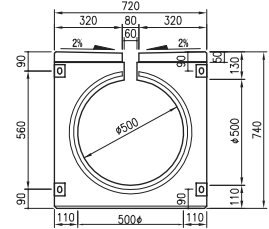

NA型 φ500用集水樹

重量：695kg

平面図

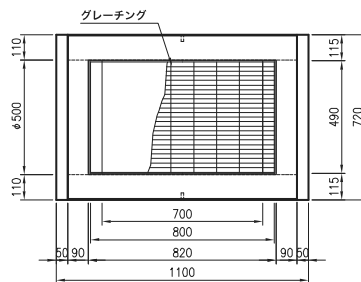

端面図

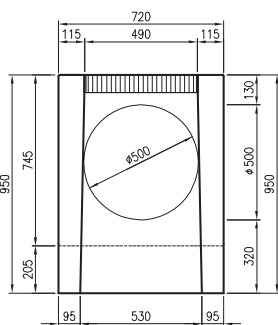

側面図

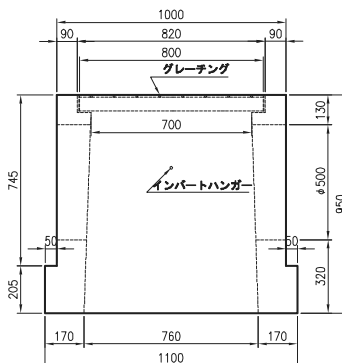

断面図

