

円形水路 NC型 (T-25)

φ250・φ250用集水桝

NC型 φ250

重量：450kg

平面図

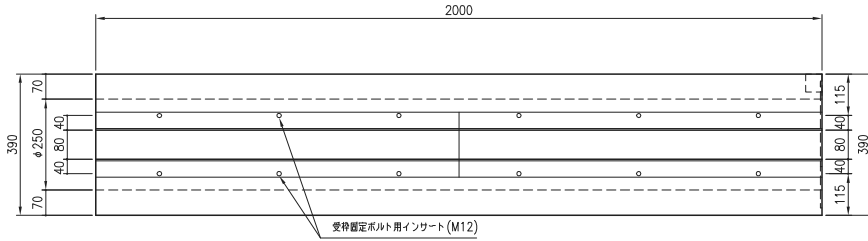

側面図

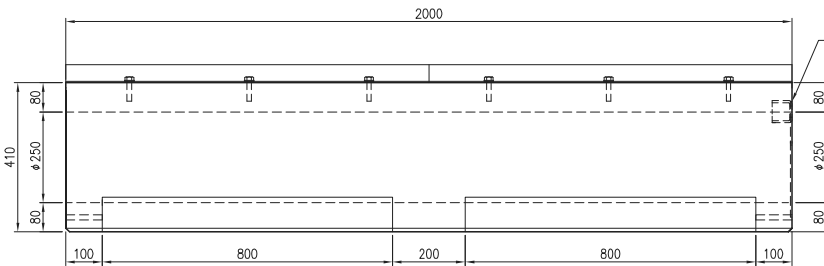

端面・断面図

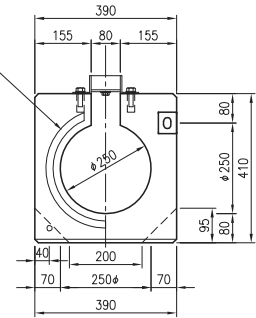

NC型 φ250用集水桝

重量：385kg

平面図

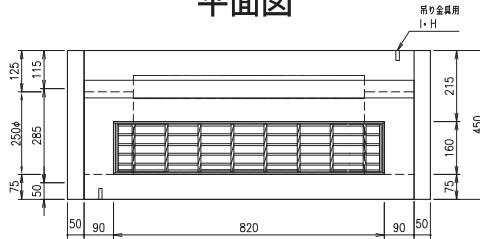

断面図

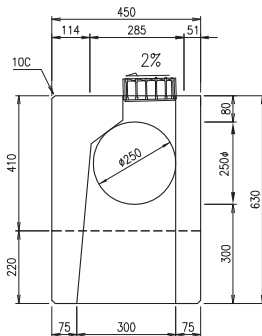

側面図

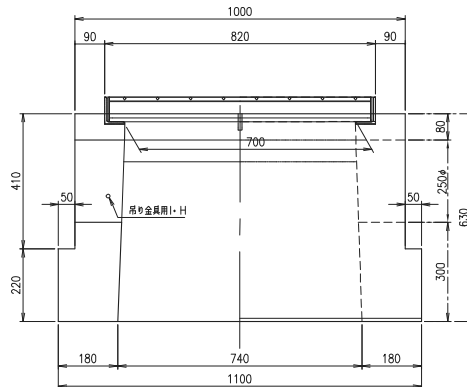

端面図

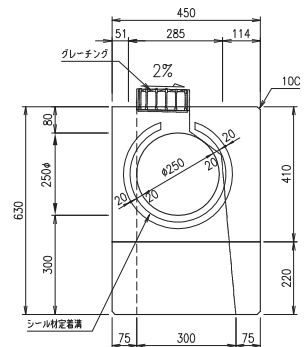

円形水路 NC型 (T-25)

φ300・φ300用集水枘

NC型 φ300

重量：550kg

平面図

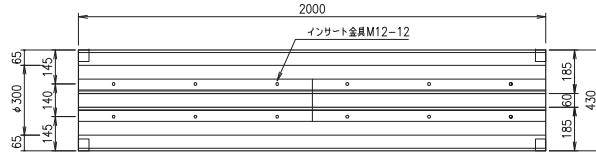

断面図

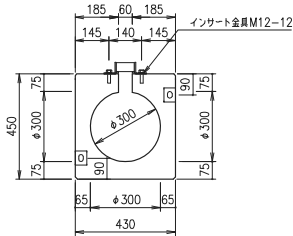

正面図

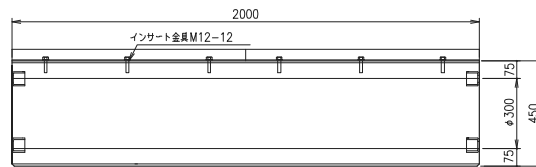

側面図

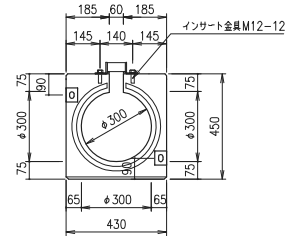

NC型 φ300用集水枘

重量：443kg

平面図

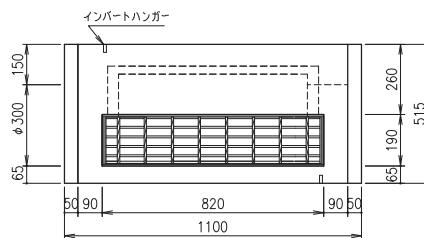

断面図

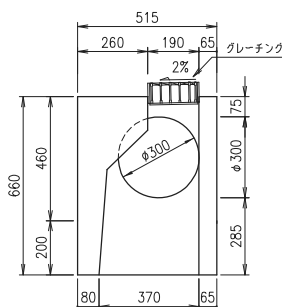

正面・断面図

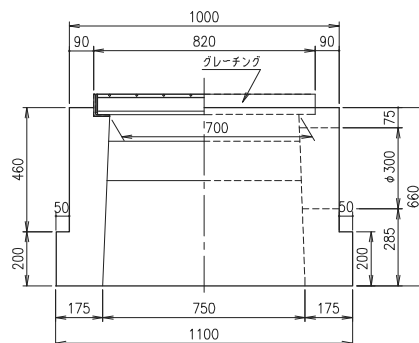

側面図

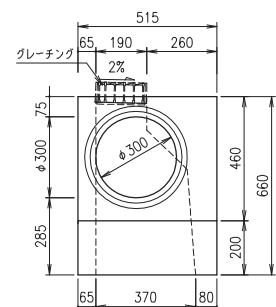

円形水路 NC型 (T-25)

φ400・φ400用集水桝

NC型 φ400

重量：1,072kg

平面図

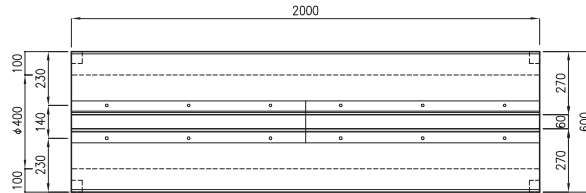

断面図

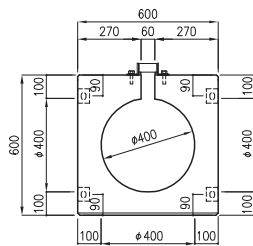

正面図

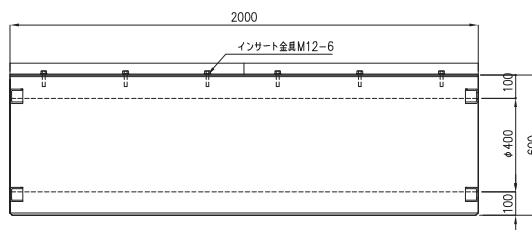

側面図

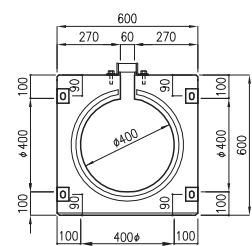

NC型 φ400用集水桝

重量：666kg

平面図

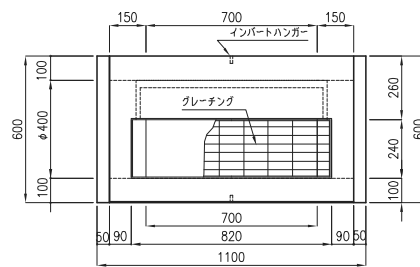

断面図

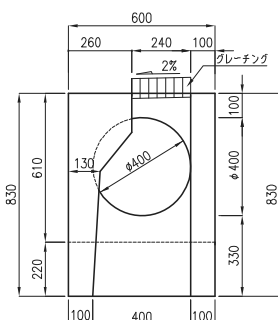

正面図

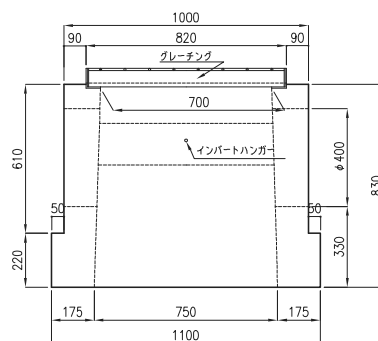

側面図

